

Publieksdag Hersentumoren

Zaterdag 16 maart 2019
De Landgoederij, Bunnik

Welke bestralingstechniek voor hersentumoren: protonen of fotonen?

Naam

Hiske van der Weide

Functie

Radiotherapeut UMCG



In samenwerking met:



Radiotherapie voor hersentumoren *patiënten*

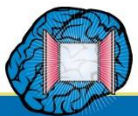
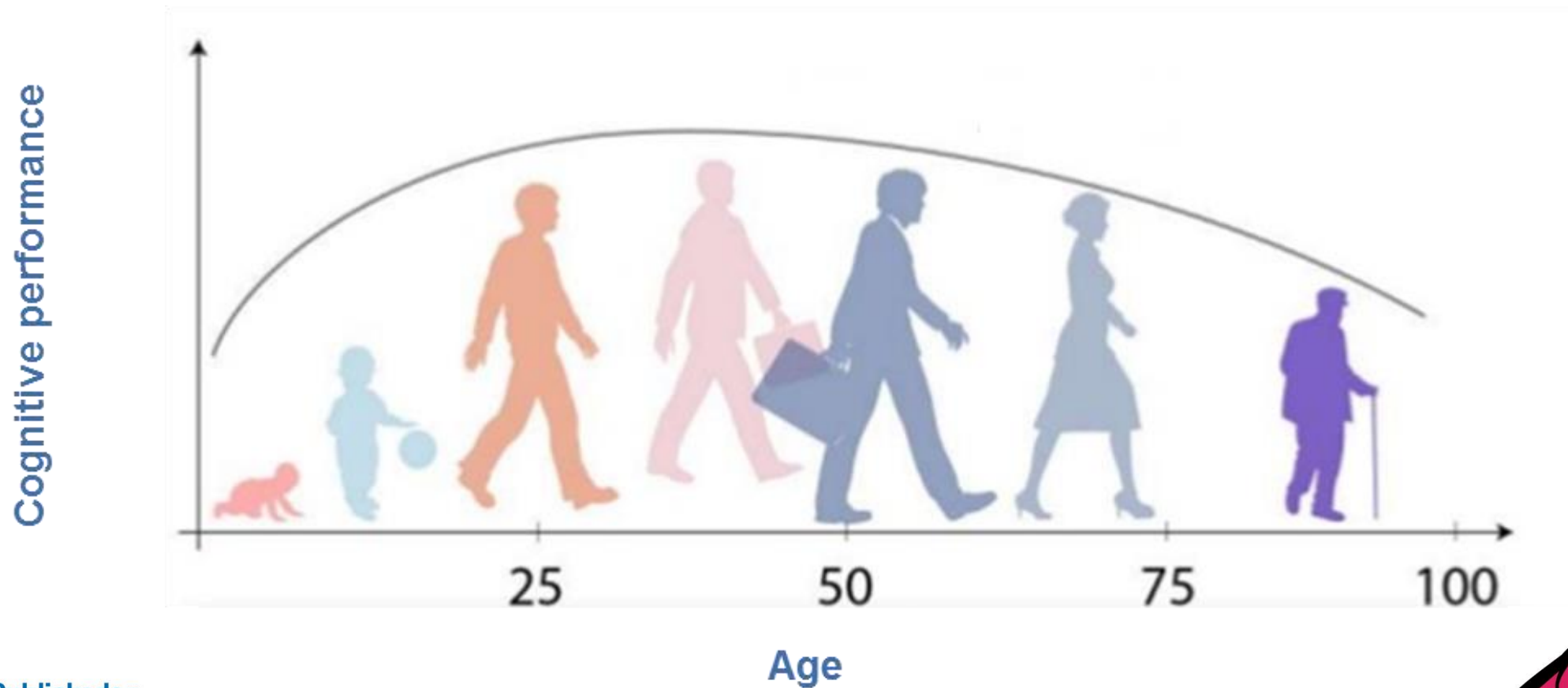

Radiotherapie voor hersentumoren *tumoren*

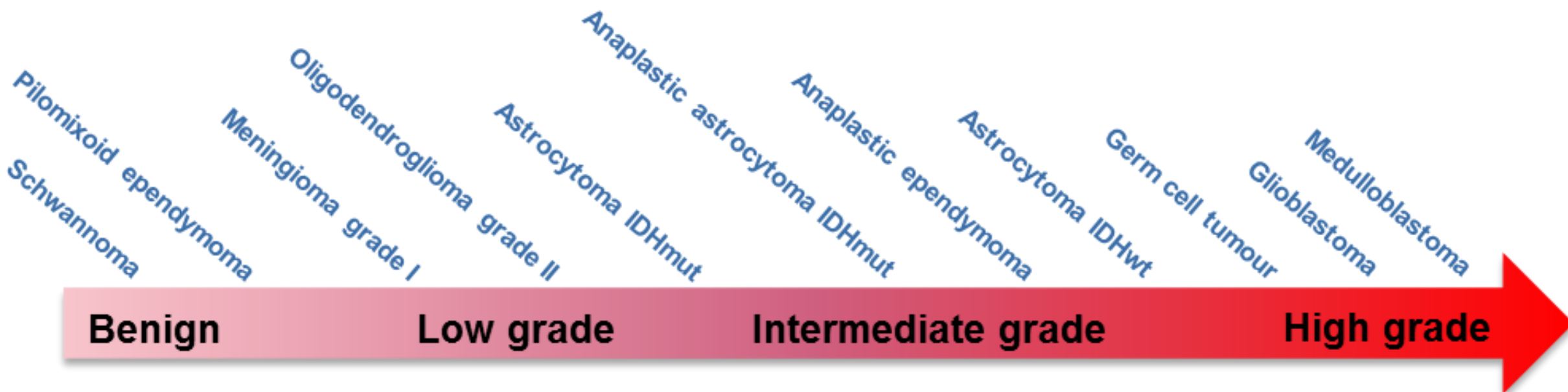

Van behandelindicatie tot behandelplan



Positionering en immobilisatie



Beeldvorming

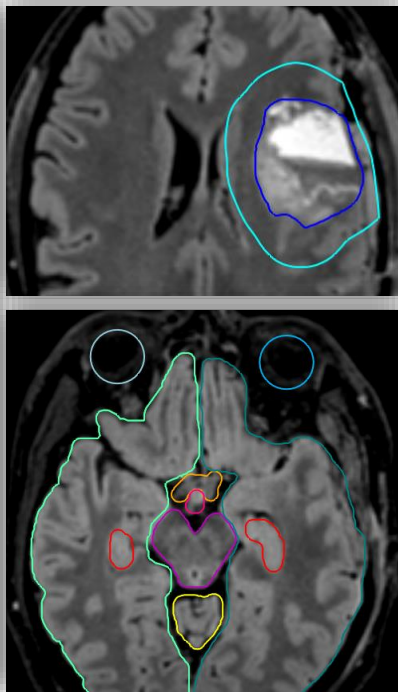

Definiëren doelvolumen

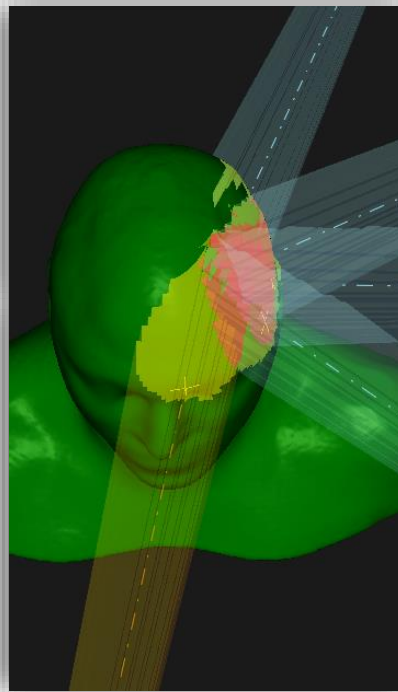

Treatment planning

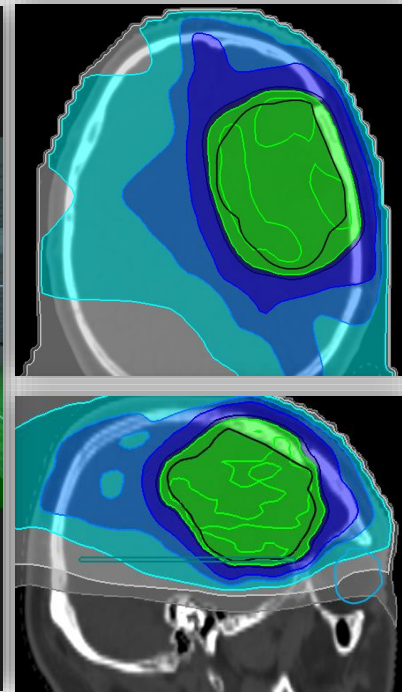

Behandelplan



Behandeling

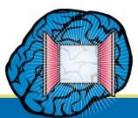

Radiotherapie voor hersentumoren *doelvolumes*

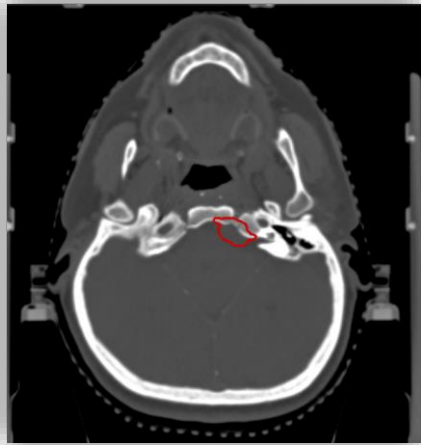

Beperkt volume

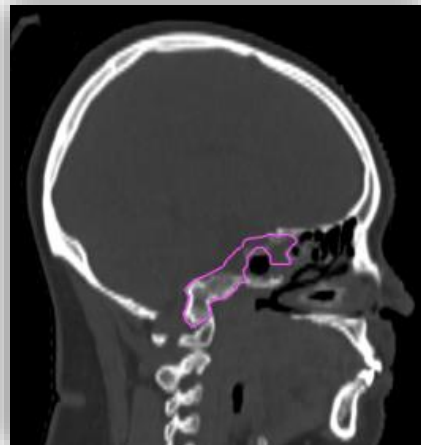

Schedelbasis



Kleine hersenen

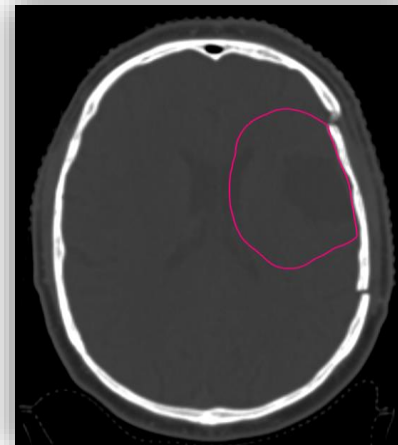

Grote hersenen



Totale hersenen en rug

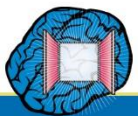

Radiotherapie technieken

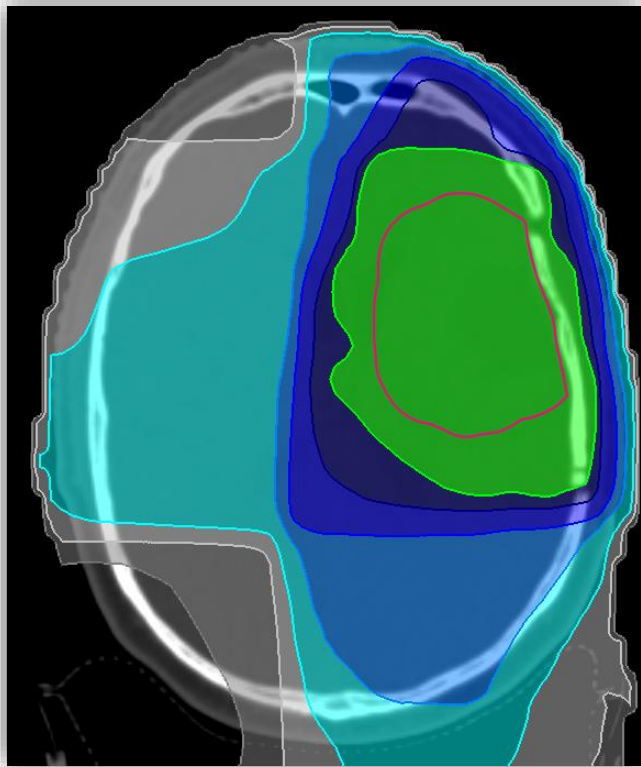

3D CRT < 2010

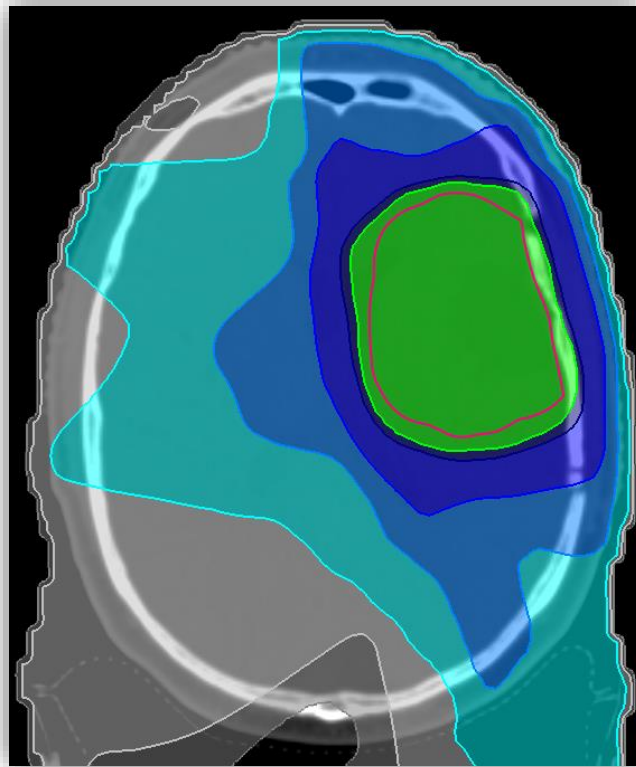

IMRT/VMAT > 2010

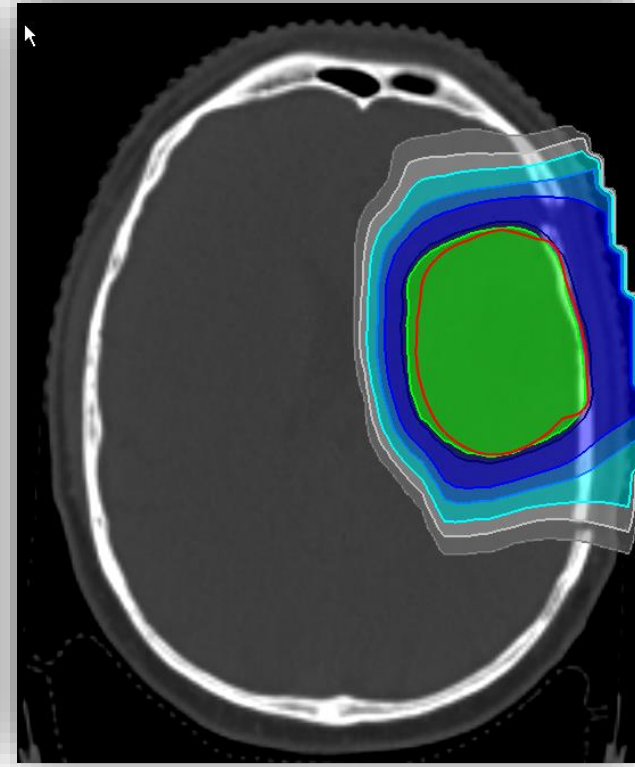

Protonen

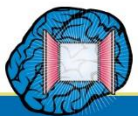

Protonentherapie *verminderen van bijwerkingen*

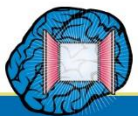
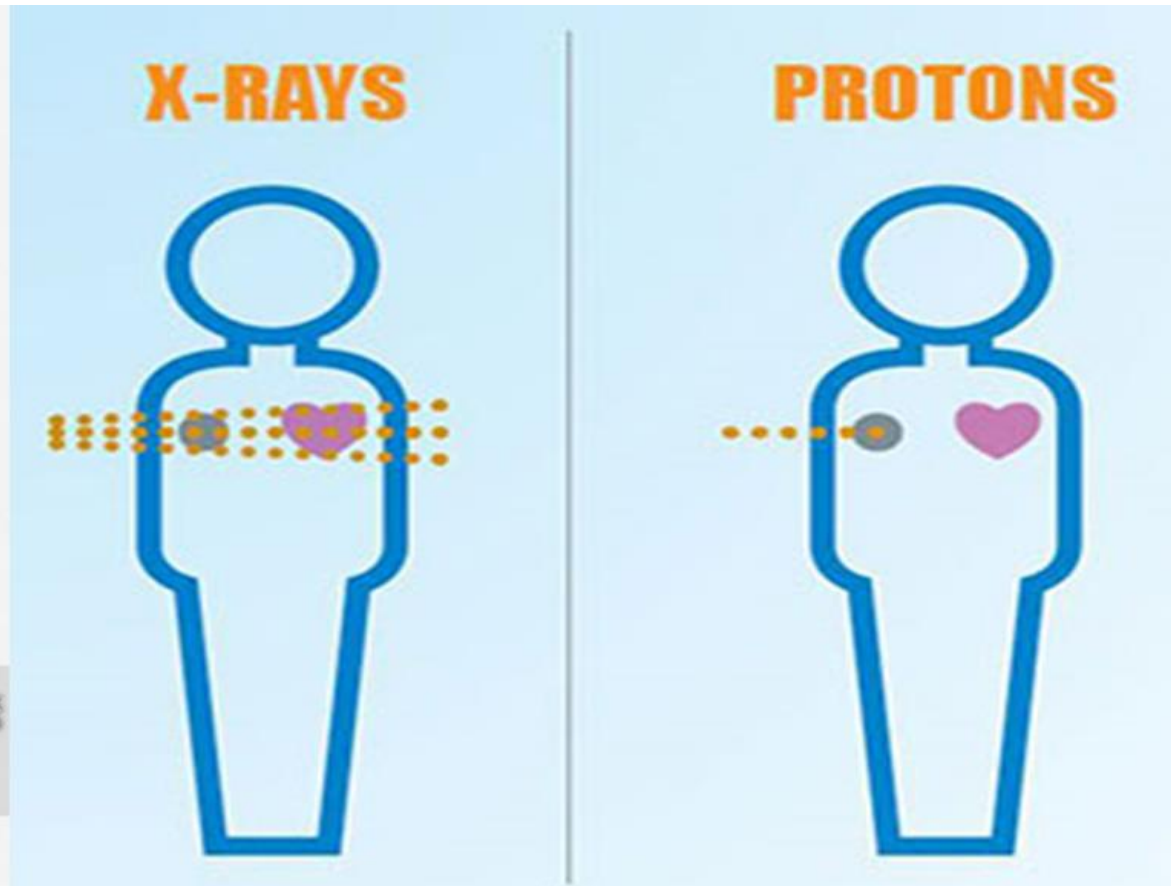
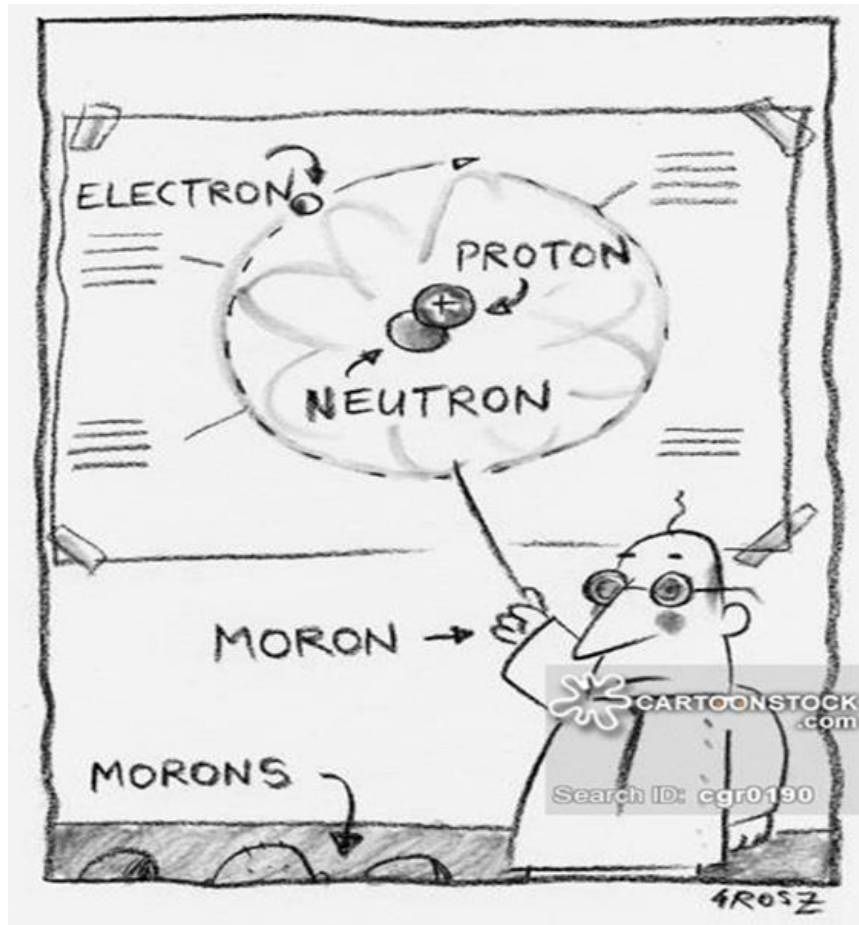

Protonentherapie *apparatuur*

Cyclotron
200 ton



Gantry
10 meter
100 ton

Beam Line
Magneten voor
sturen en focussen

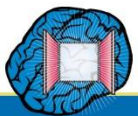
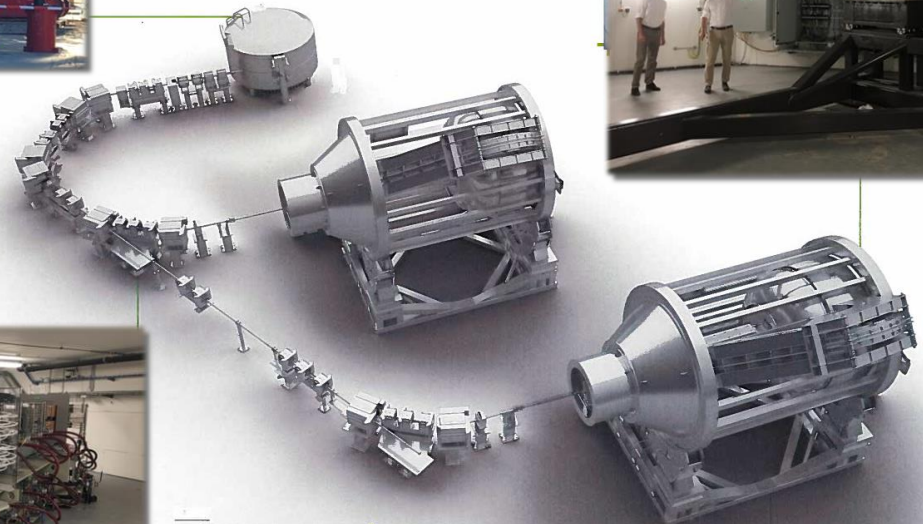

Protonentherapie *behandelruimte*

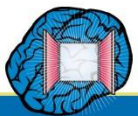

Protonentherapie *beschikbaarheid*

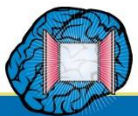
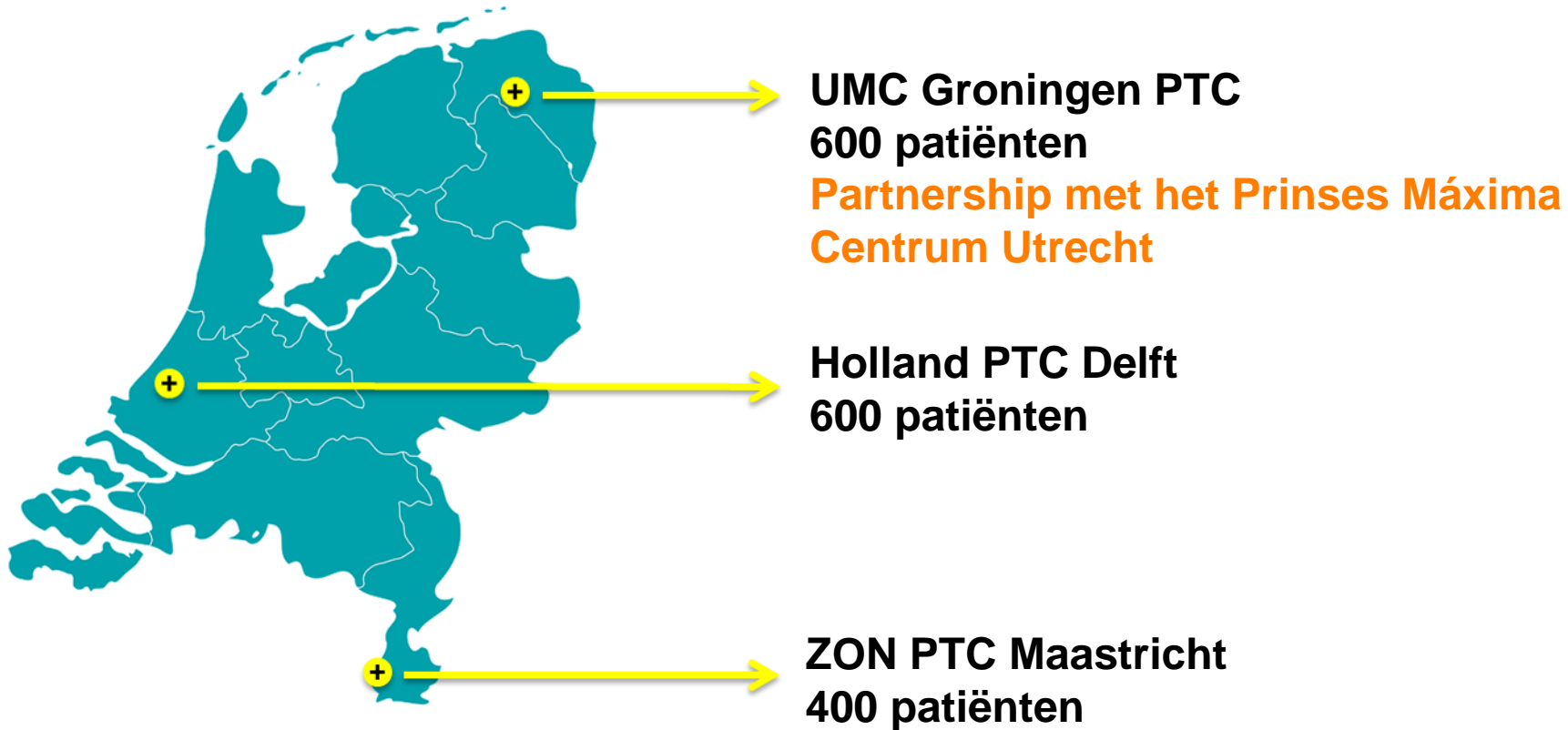

Wanneer protonentherapie?

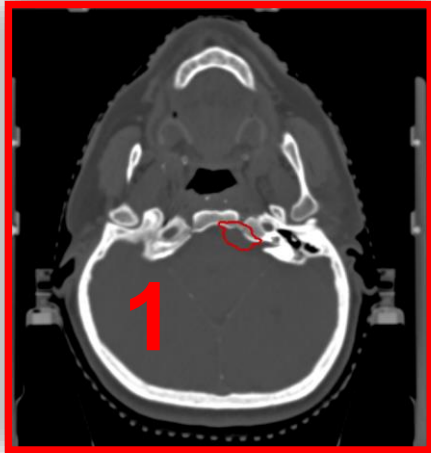

Beperkt volume

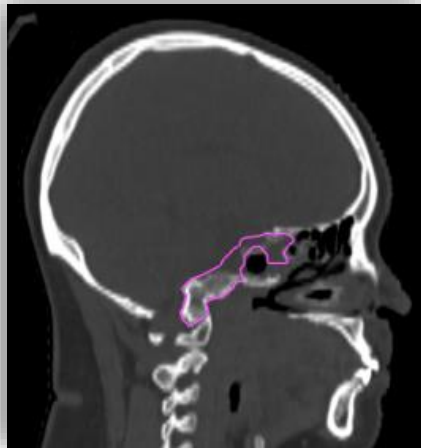

Schedelbasis

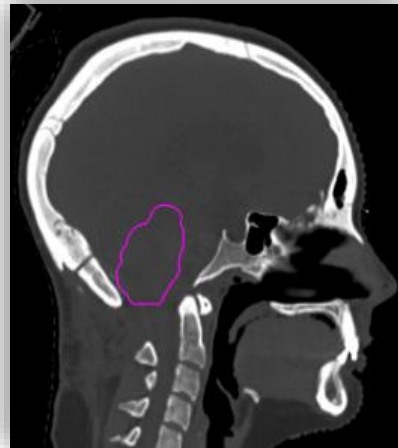

Kleine hersenen

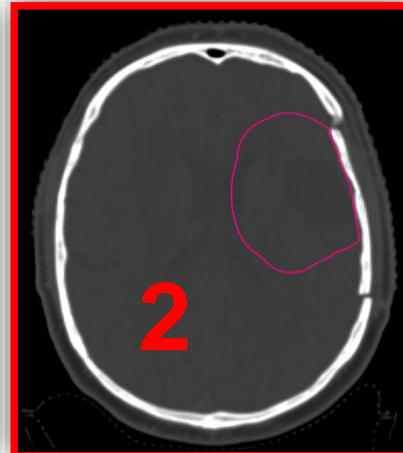

Grote hersenen

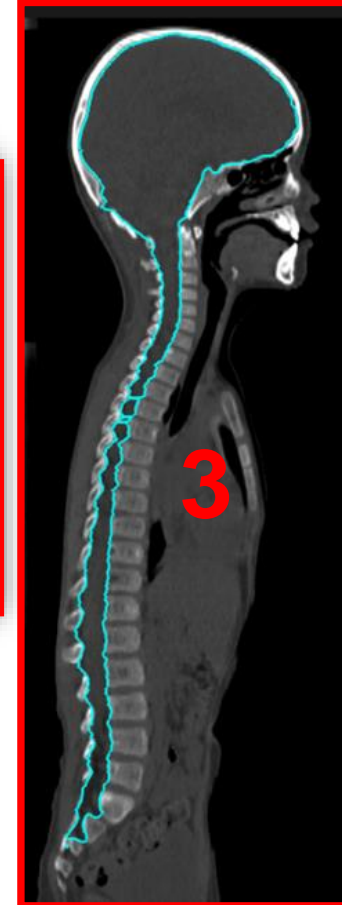

Totale hersenen en rug

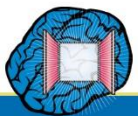

1. Beperkt volume – stereotactische fotonen voorkeur

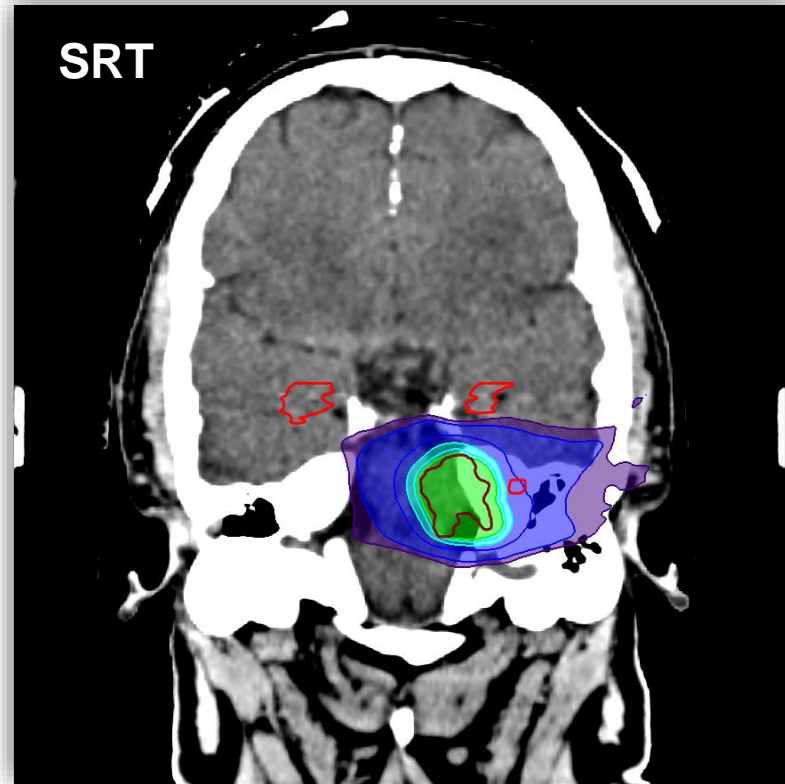

Fotonen SRT

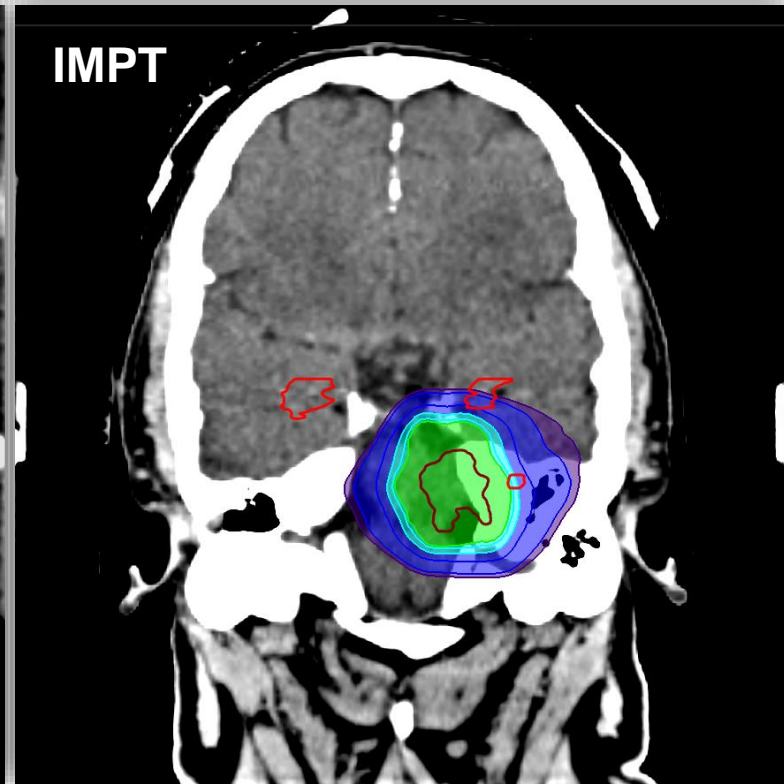

Protonen

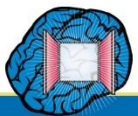

2. Grote hersenen – individuele afweging

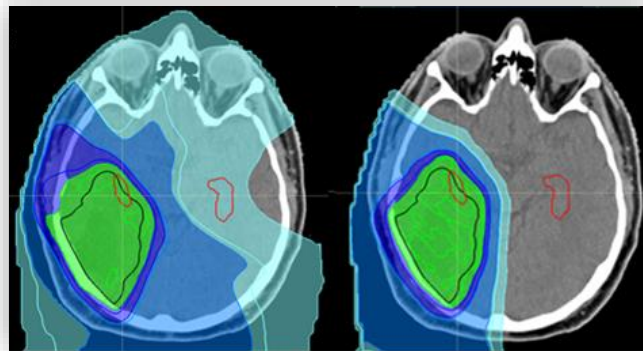
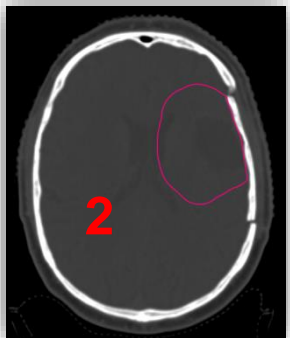

Fotonen

Protonen

Slechte prognose

Agressieve tumor

Weinig dosis winst

Veel klachten van de tumor

Behandeling dicht bij huis

Jonge leeftijd

Gunstige prognose

Laaggradige tumor

Weinig klachten van de tumor

Sterk gemotiveerde patiënt

Veel dosis winst

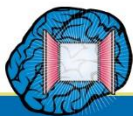

3. Totale hersenen en rug – protonen voorkeur

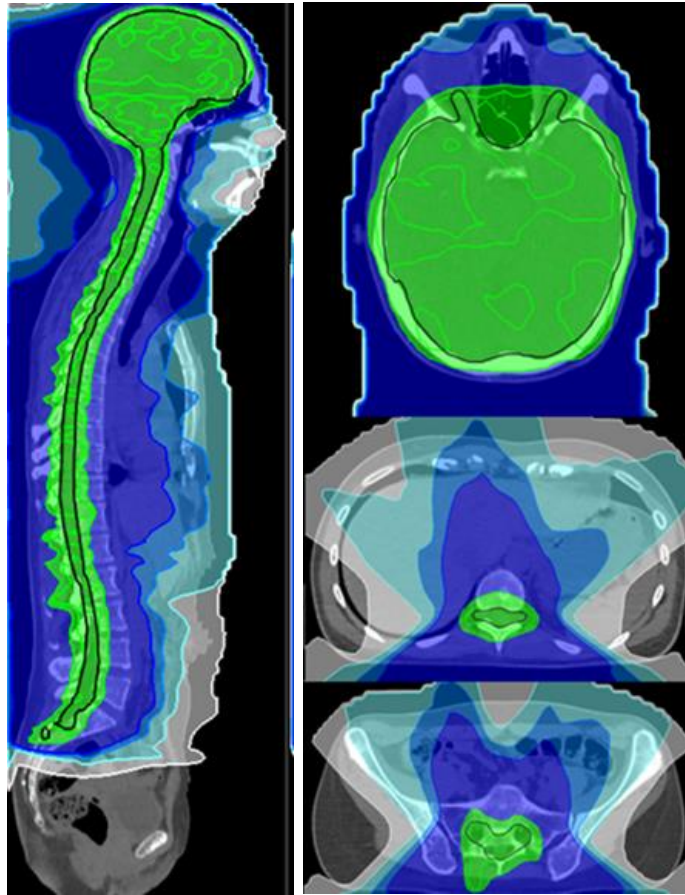

Fotonen

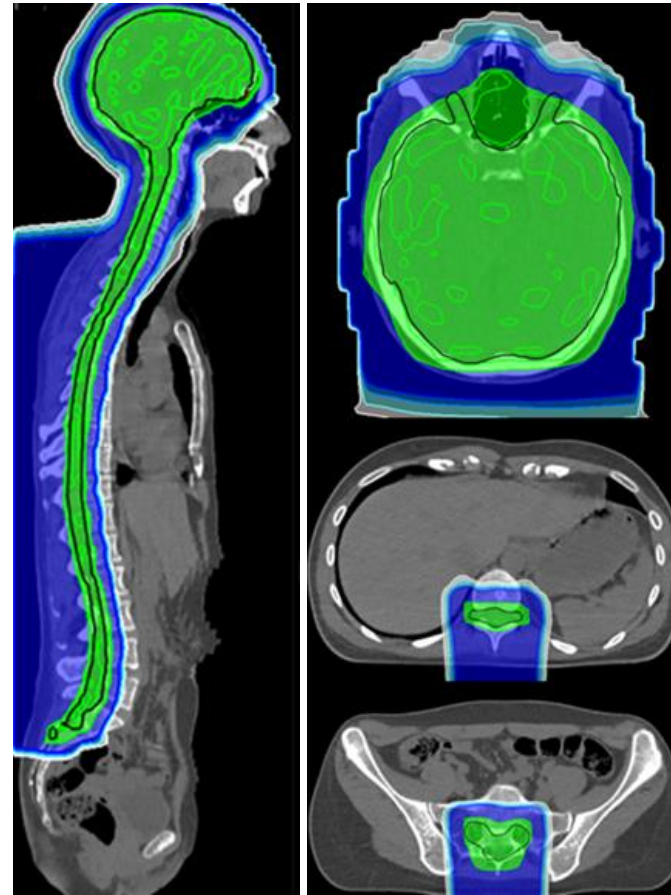

Protonen



Protonentherapie in Groningen

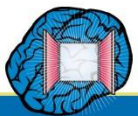

Multidisciplinaire zorg



Neuro-oncologen



Neuro-psychologen



**Kinder-
neuroloog**



Protonen anesthesie team

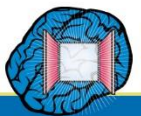

Samenwerking met het Prinses Maxima Centrum Utrecht

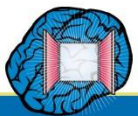

Behandelde patiënten met hersentumor 2018- heden



Totaal	66
Kind met narcose	19
Kind zonder narcose	22
Volwassen	25

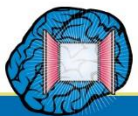



THINK LIKE
A PROTON.
ALWAYS
POSITIVE.

